

Article number: 2011301675ST
 Description: E+G Lifting pins in Steel,
 GN 1130-16-75-ST

Measures

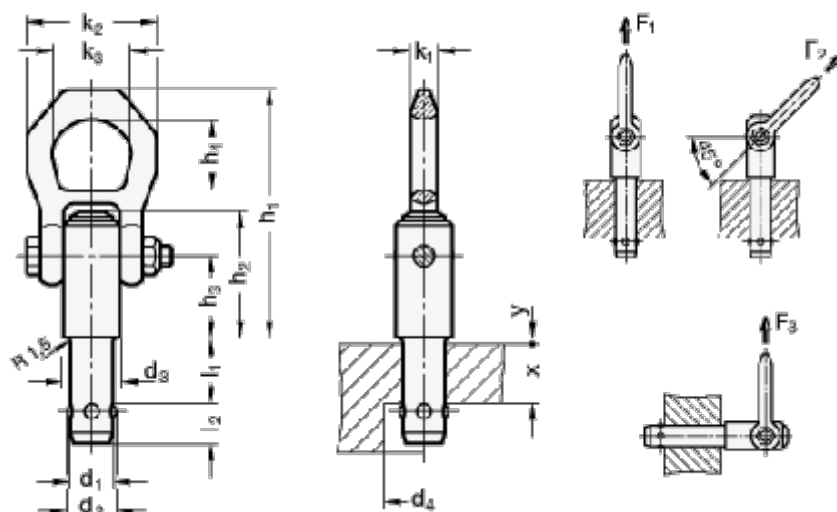

d1	= 16	h4	= 27	y = 1.5
d2	= 18.600000000000001	l1	= 75	
d3	= 25	l2	= 15.1	
d4	= 19.2	k1	= 11	
F1/F2/F3 load in kN	= 4,8/4,5/4,1	k2	= 49	
h1	= 92.5	k3	= 30	
h2	= 47.5	Weight (g)	= 392	
h3	= 31	x	= 35	